

METROPOLITAN ST. LOUIS SEWER DISTRICT

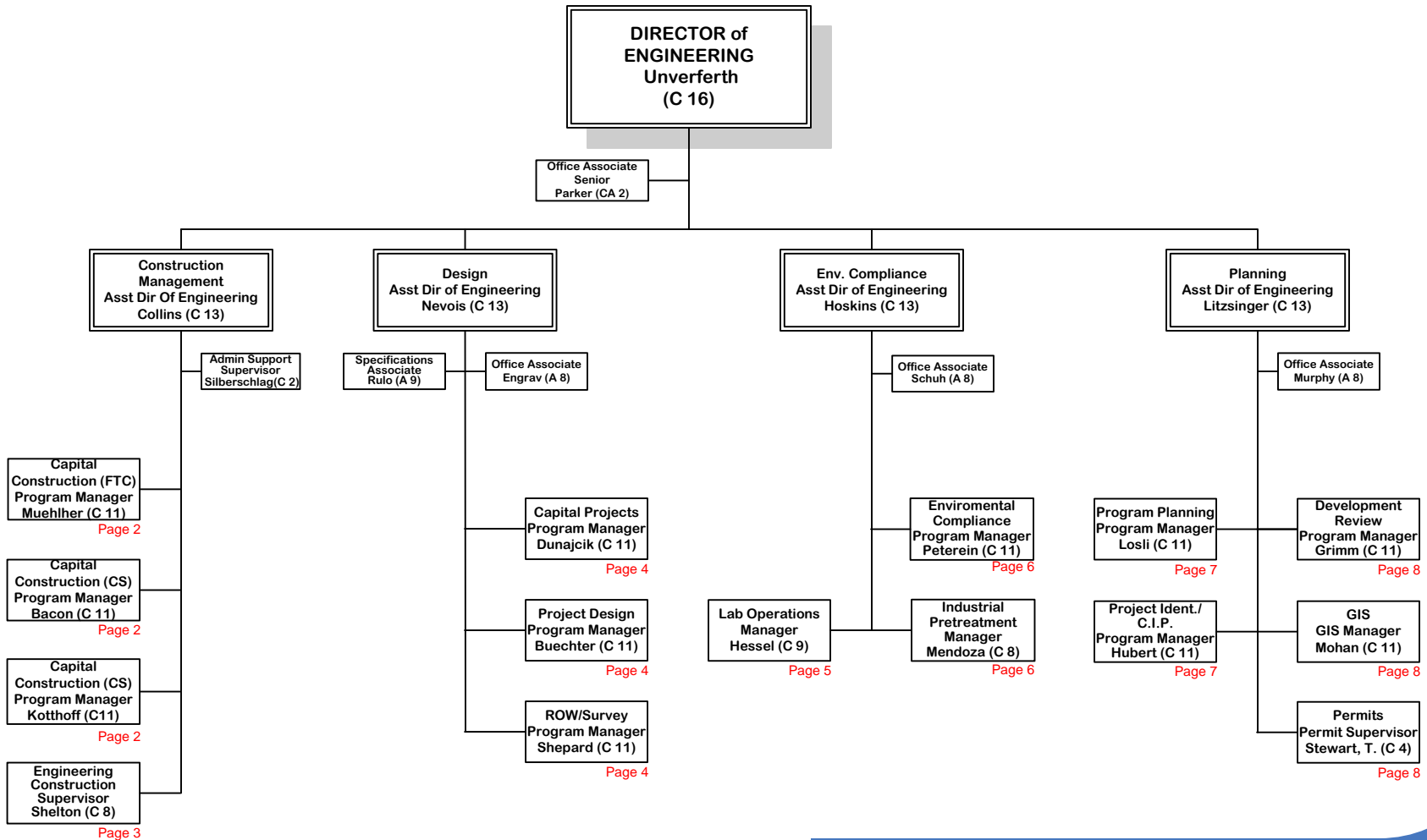

ENGINEERING DEPARTMENT



METROPOLITAN ST. LOUIS SEWER DISTRICT



ENGINEERING DEPARTMENT

CONSTRUCTION MANAGEMENT DIVISION

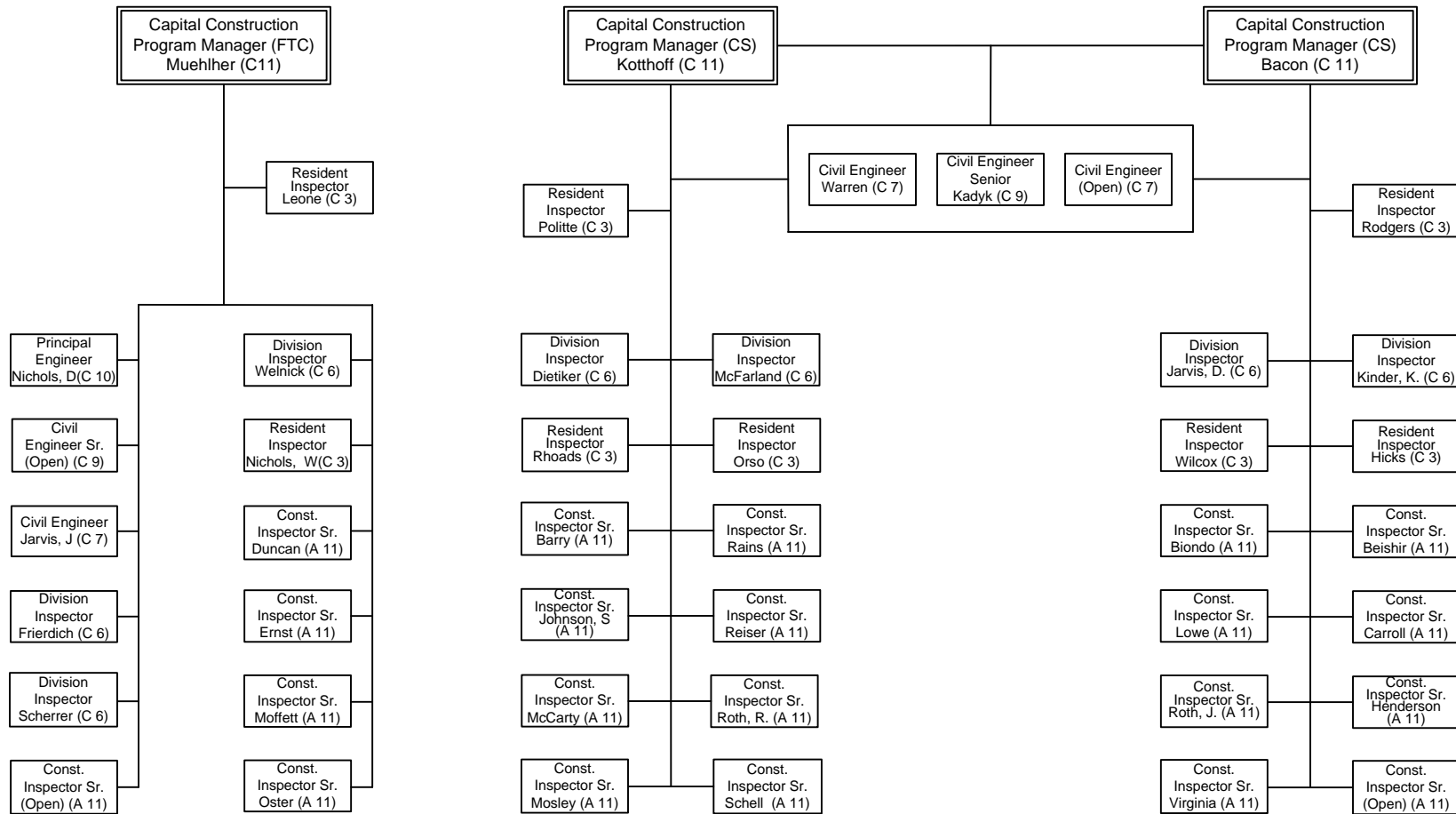

METROPOLITAN ST. LOUIS SEWER DISTRICT



ENGINEERING DEPARTMENT CONSTRUCTION MANAGEMENT DIVISION

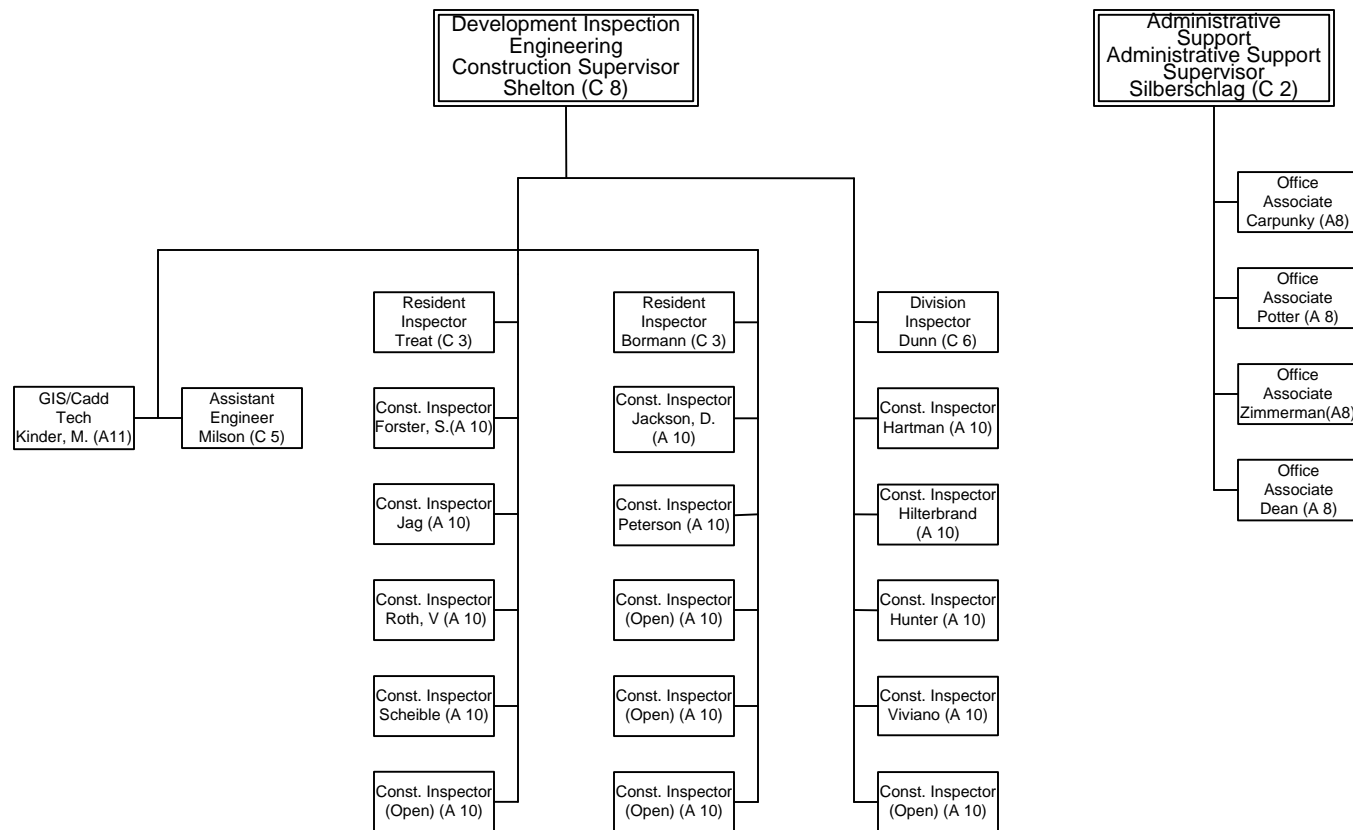

METROPOLITAN ST. LOUIS SEWER DISTRICT



ENGINEERING DEPARTMENT

DESIGN

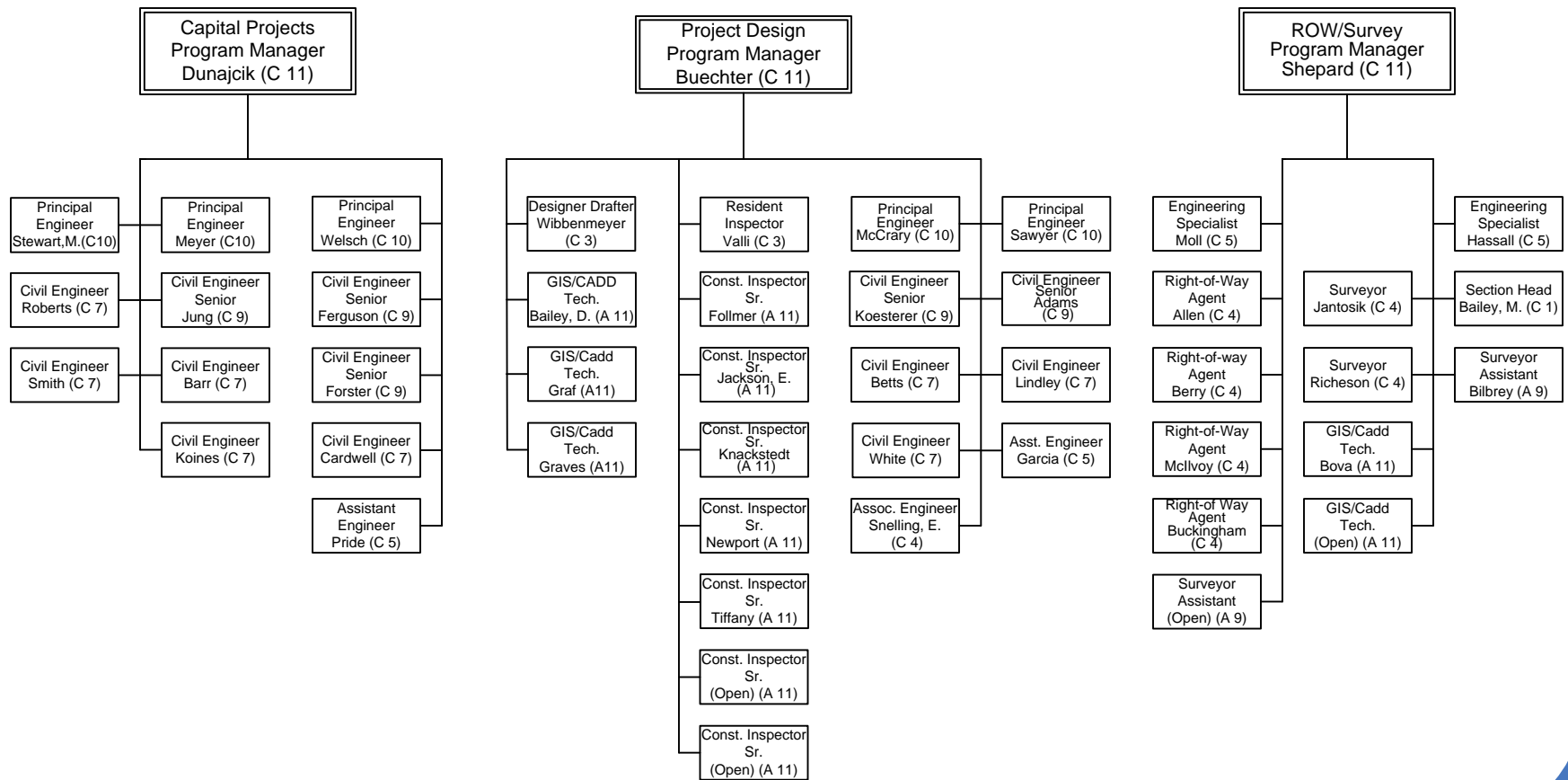

METROPOLITAN ST. LOUIS SEWER DISTRICT



ENGINEERING DEPARTMENT

DIVISION OF ENVIRONMENTAL COMPLIANCE (DEC)

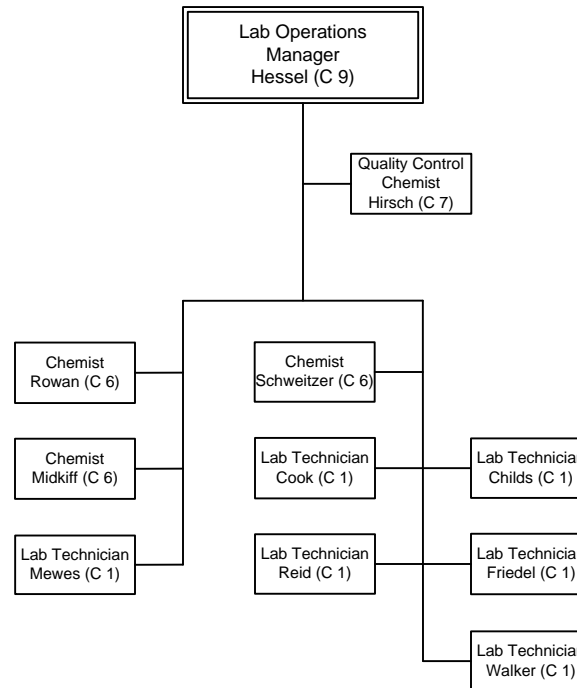

METROPOLITAN ST. LOUIS SEWER DISTRICT



ENGINEERING DEPARTMENT

DIVISION OF ENVIRONMENTAL COMPLIANCE (DEC)

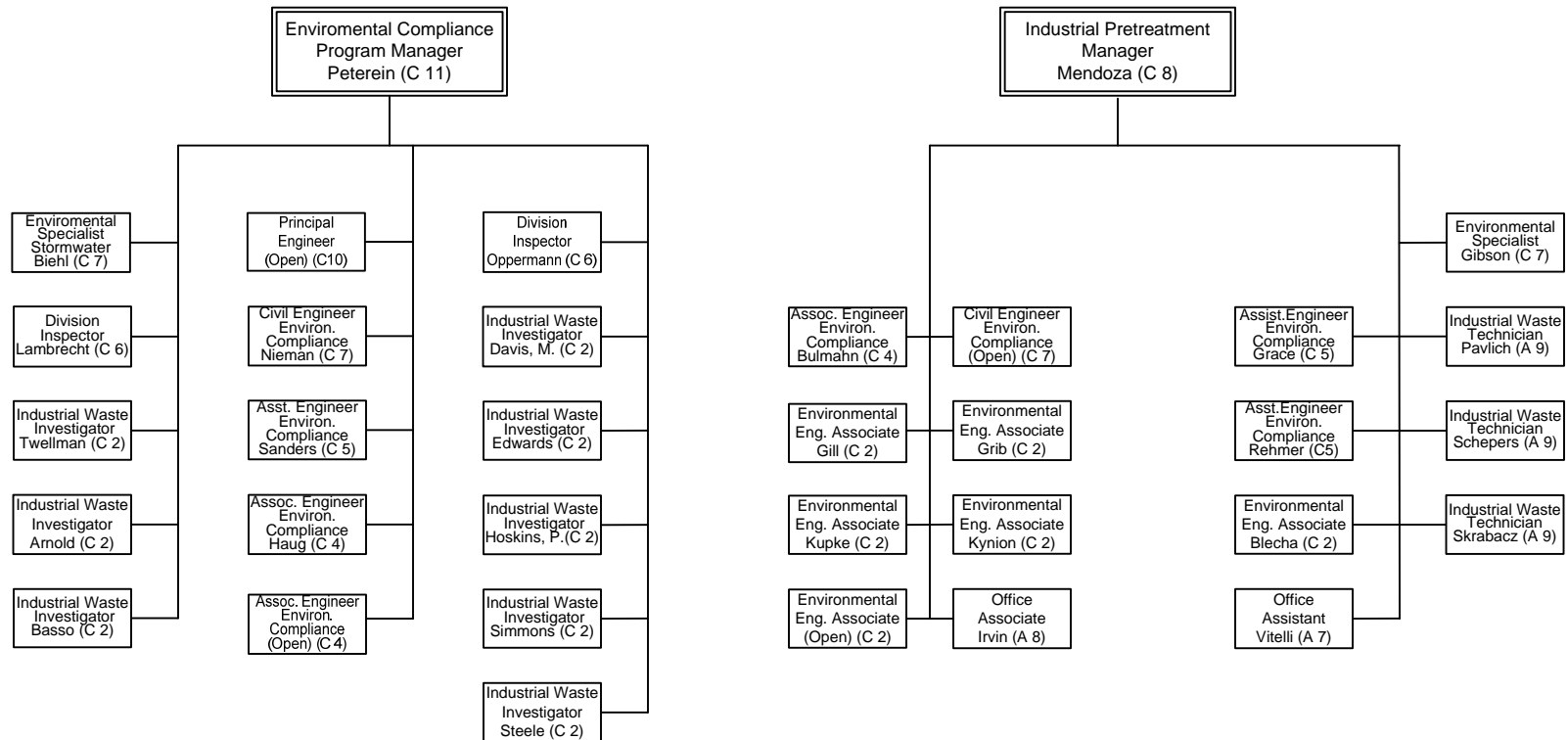

METROPOLITAN ST. LOUIS SEWER DISTRICT



ENGINEERING DEPARTMENT

PLANNING DIVISION

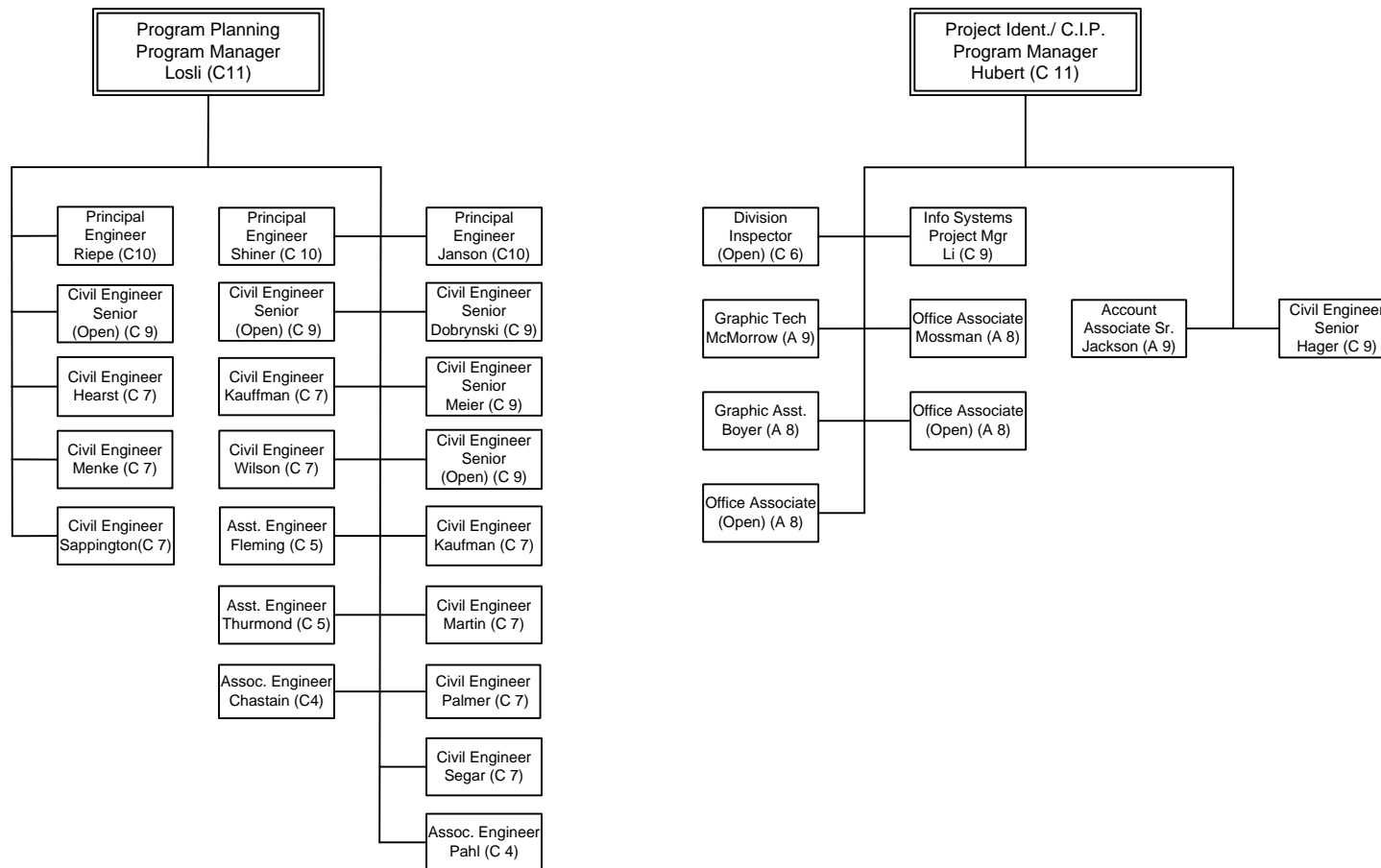

METROPOLITAN ST. LOUIS SEWER DISTRICT



ENGINEERING DEPARTMENT

PLANNING DIVISION

